



Les triangles

Géom ...

MÉMO

Un triangle est un polygone à 3 côtés.

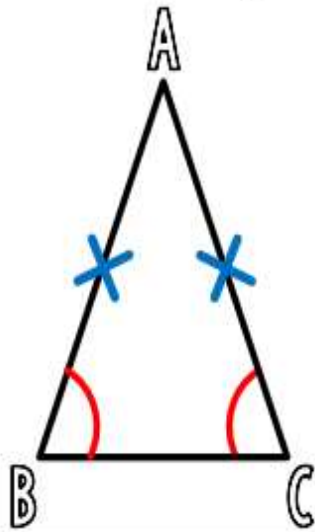

le triangle isocèle

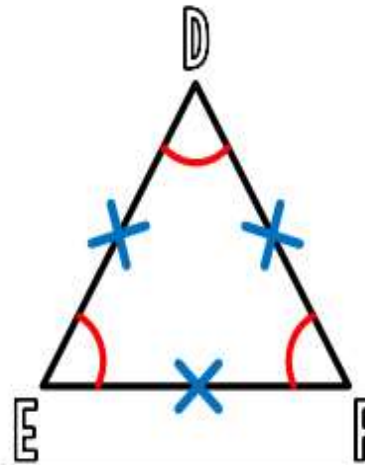

le triangle équilatéral

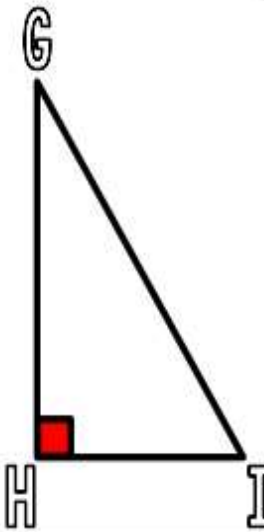

le triangle rectangle

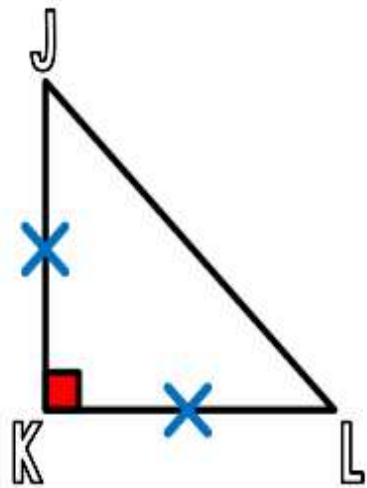

le triangle isocèle rectangle

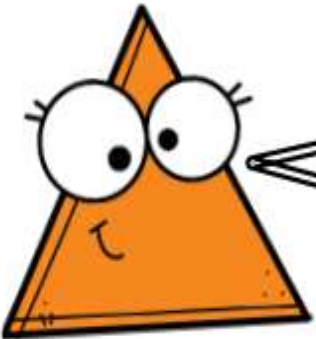

Pour construire un triangle, tu as besoin d'une règle et d'un compas !

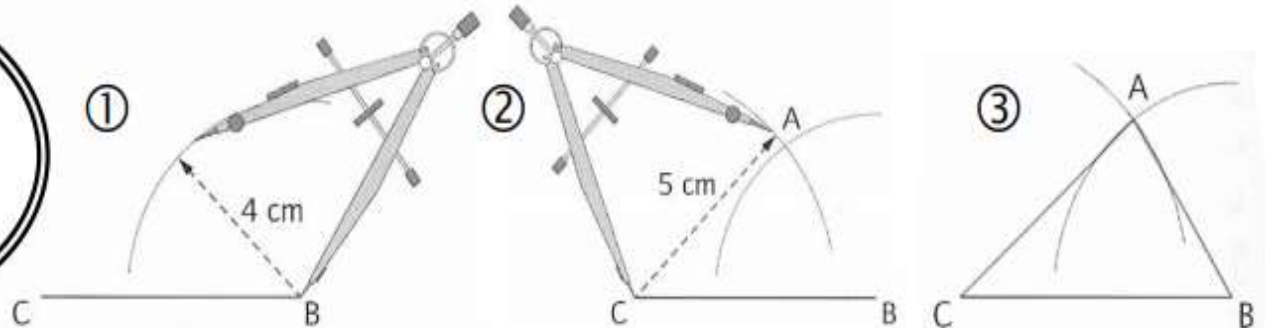



Les triangles

Géom ...

MÉMO

Un triangle est un polygone à 3 côtés.

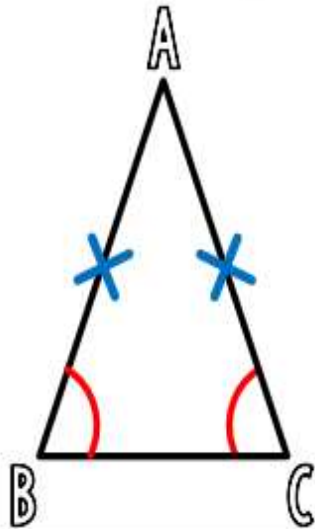

le triangle isocèle

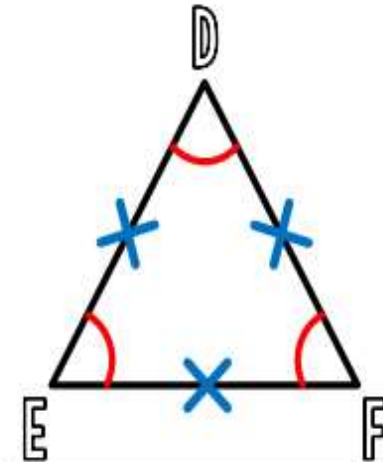

le triangle équilatéral

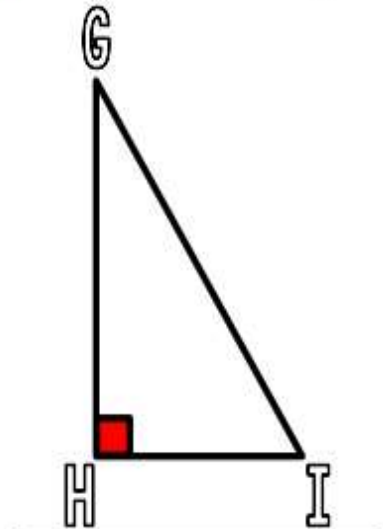

le triangle rectangle

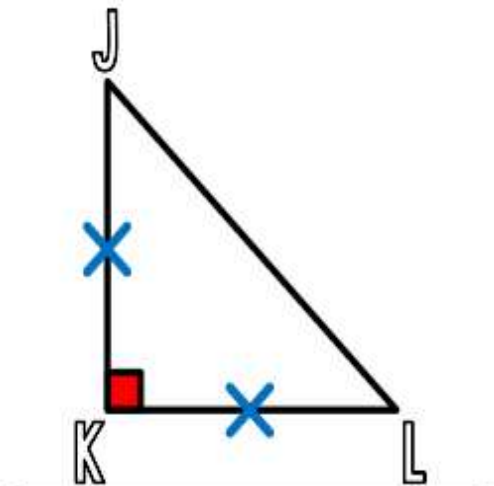

le triangle isocèle rectangle

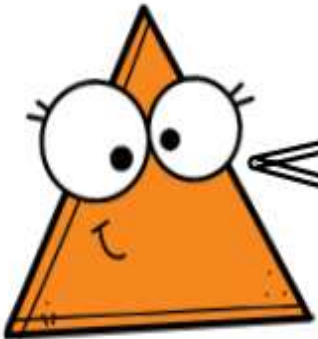

Pour construire un triangle, tu as besoin d'une règle et d'un compas !

